

Magnetic Proximity Sensor/Switch Datasheet

CMS-5 Magnetic Proximity Sensor

Introduction

- Magnetic switch is also called the magnetron, which is a switching element controlled by the magnetic field signal. Disconnect once non-magnetic.
- Magnetic switches are used to detect circuit or the state of mechanical movement and widely applied in Security Door, household doors, printers, fax machines, telephones and other electronic equipment.
- It is divided into two categories according to the working state :
NO - Normal Open type,
NC - Normal Close type

Features:

- ◆ Small size, light weight, easy installation
- ◆ Good installation performance, suitable for all kinds of complex environment
- ◆ Long life-span, high reliability and high stability
- ◆ Sensor induction surface can be made of metal
- ◆ Power supply reversal connection protection; short-circuit protection, can directly connect with PLC
- ◆ Newly added current over-load protection; the elements are made of imported chip
- ◆ Long service life, high reliability and strong resistance property to environment
- ◆ Red LED indicates that it's available to detect the sensor operating state
- ◆ IP65 protection structure(IEC specification)

Ordering Part Number:

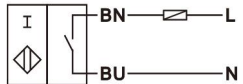
Model	Continuous load current	Switch point function	Working voltage	Connection form
CMS-5	100mA	AC NO	DC/AC5-220V	AC NO 

Structure Parameter:

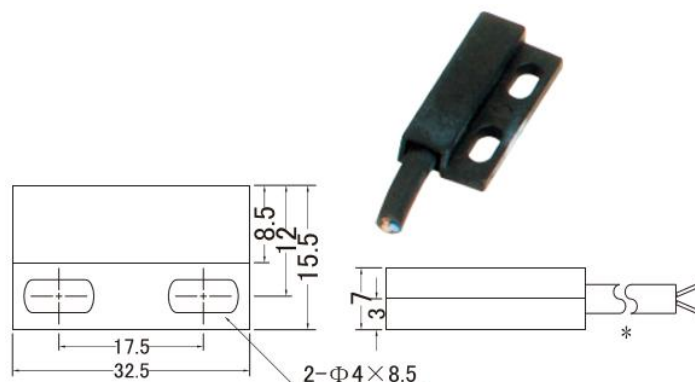

Magnetic Proximity Sensor/Switch Datasheet

Technical Parameter:

Dimension	7×14.8×33mm
Hysteresis	Typical value%
Reverse polarity protection	Yes
Short-circuit protection	Pulse
Working current (I _L)	0~300 mA
Leakage current (I _r)	0~0.5mA typical values 0.1uA, 25°C
No-load current (I _D)	≤15mA
Continuous load current	100mA
Indicator light	Red LED
environment temperature	-20°C~70°C(248-343K)
Connection form	2m, PVC
Conductor cross-sectional area	0.14mm ²
Shell material	PBT
Induction surface	PBT
Protection grade	IP65
Standard	EN 60947-1:2004

Remarks:

- Magnetic induction type, can detect the position of the plunger in the cylinder.
- The detection distance may fluctuate with the different materials of the detected target. Custom design in the different rated input current and the output voltage are available.
- Both the configuration parameters and the cable length can be customized. Standard cable length 2m.
- If no explicit requirement for the output polarity, the proximity sensor will be supplied based on NPN mode.

WARNING : Incorrect wiring may cause damage to the sensor.